

mcmurdo



SMARTFIND E5 and G5 EPIRB User Manual

SOS

ONLY IN EMERGENCY

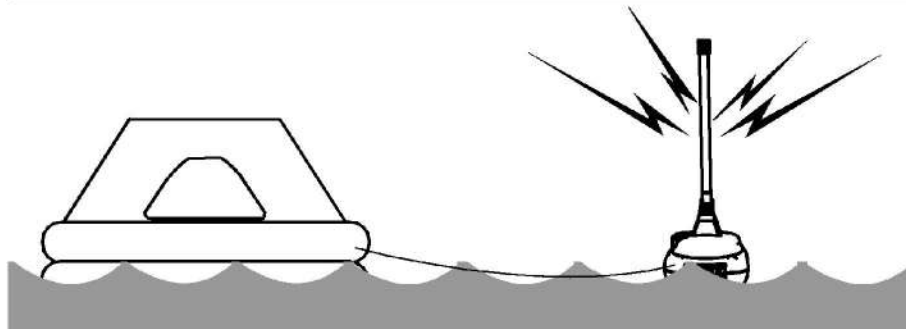
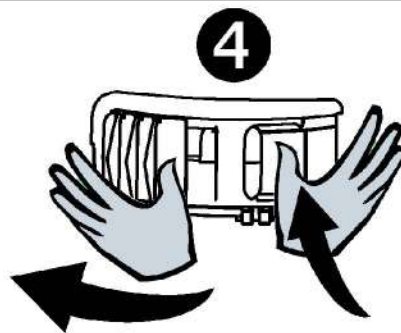
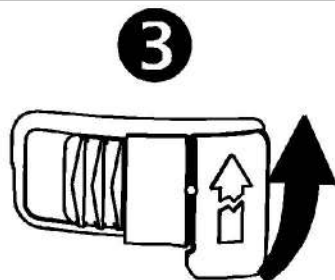
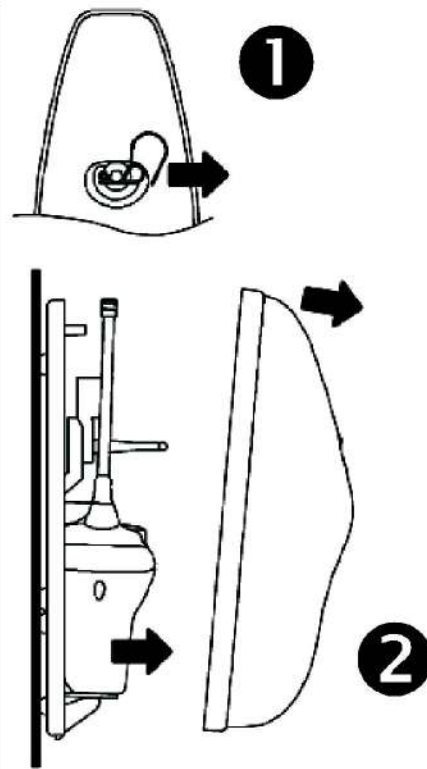
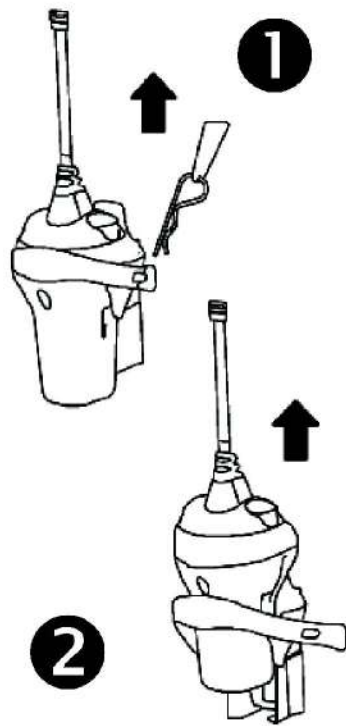

Contents

1	OVERVIEW	5
2	DESCRIPTION	6
3	CONTROLS AND INDICATORS	7
4	EPIRB STOWAGE	8
5	EPIRB OPERATING PROCEDURE.....	10
6	GETTING THE BEST FROM THE EPIRB	12
7	FALSE ALERTS	15
8	INSTALLATION	16
9	SELF TEST	20
10	MAINTENANCE	21
11	SPECIFICATION	25
12	WARRANTY STATEMENT	26
13	END OF LIFE STATEMENT	27
14	ANNEX 1. REGISTRATION INFORMATION	28

Disclaimer

The information and illustrations contained in this publication are to the best of our knowledge correct at the time of going to print. We reserve the right to change specifications, equipment, installation and maintenance instructions without notice as part of our policy of continuous product development and improvement. No part of this publication may be reproduced, stored in a retrieval system or transmitted in any form, electronic or otherwise without permission in writing from Orolia Ltd. No liability can be accepted for any inaccuracies or omissions in the publication, although every care has been taken to make it as complete and accurate as possible. This manual is applicable for McMurdo Smartfind E5 and G5 version 2 EPIRBs manufactured after January 2013.

1 OVERVIEW

This Emergency Position Indicating Radio Beacon (EPIRB) is intended for carriage on SOLAS and non-SOLAS vessels. When carrying an EPIRB on board you enjoy the reassurance of a last resort safeguard against any life threatening incidents that may occur anywhere in the world. Only operate the EPIRB in situations of grave and imminent danger to life. False alerts endanger lives. Help prevent them by understanding how to look after the EPIRB.

Cospas Sarsat system

EPIRBs transmit a unique emergency message identifier via the Cospas-Sarsat satellite system which can determine your location anywhere on the earth's surface. In most cases the first emergency alert is received within 5 minutes of activation, depending on satellite coverage at the time this can sometimes extend to around 45 minutes. When the emergency alert message is received at a Rescue Co-ordination Centre (RCC) it is cross referenced by the Unique Identifier Number (UIN) against user registration information. Details of the alert will be forwarded to the appropriate local Search and Rescue (SAR) teams. Keeping your vessels registration details up to date is critical to ensuring a quick SAR response. If you have purchased the GPS version, it has a built-in GPS receiver which can reduce the time for Search and Rescue teams to arrive on scene, as your precise coordinates are transmitted within the first few minutes. Non-GPS versions are pinpointed using Doppler Shift from the over-flying satellites.

EPIRBs have a secondary or 'homing' transmitter which allows SAR teams to direction find or 'home in' on the EPIRB once they arrive on the scene. Once activated the EPIRB will continue to transmit emergency alerts for a minimum of 48 hours.

For further information visit Cospas-Sarsat on line at www.cospas-sarsat.org

You must register your EPIRB with the appropriate authorities.

Failure to file a valid user register may slow the rescue and lead to loss of life.

The EPIRB is pre-programmed with a Unique Identity Number (UIN) before it reaches the end customer. The UIN must be registered with the national authority indicated in the white area of the label on the rear of the EPIRB. Complete the included user registration form and return it to the address indicated. As some authorities may require online registration always check for any guidance notes printed on the registration form. The country code programmed into your EPIRB is shown on the rear identity label. You **must** register your vessel and contact details with the authorities in that country.



How to register

Refer to Annex 1. for details of specific national user registration requirements.

Always ensure that any changes of registration or contact details are promptly notified.

2 DESCRIPTION

An EPIRB is intended to be a one-shot device. Once activated it will transmit emergency alerts for at least 48 hours. The EPIRB will work best while floating in water, but can also be operated while on board a vessel, in a liferaft or on land (when placed on the ground).

The key components of your EPIRB are:

- Antenna** Flexible whip, should be near vertical when operating.
- Strobe Light** Flashing signal light, visible through the clear lens dome when the EPIRB is switched on.
- LED** Indicates the current operating status, visible through the clear lens dome.
- Activation switch** Protected by a tear-off anti-tamper tab. Break the tab upwards, push the switch in and move it fully left to activate the EPIRB.
- Sea switch** The two studs on the sides of the EPIRB are sea switch contacts. Submerge these in water to activate the EPIRB automatically.
- Test button** Self test verifies the readiness of the EPIRB.
- Lanyard** Pull the lanyard spool down to free it. Use the cord to tether the EPIRB to a PFD (Personal Flotation Device) or survival craft.

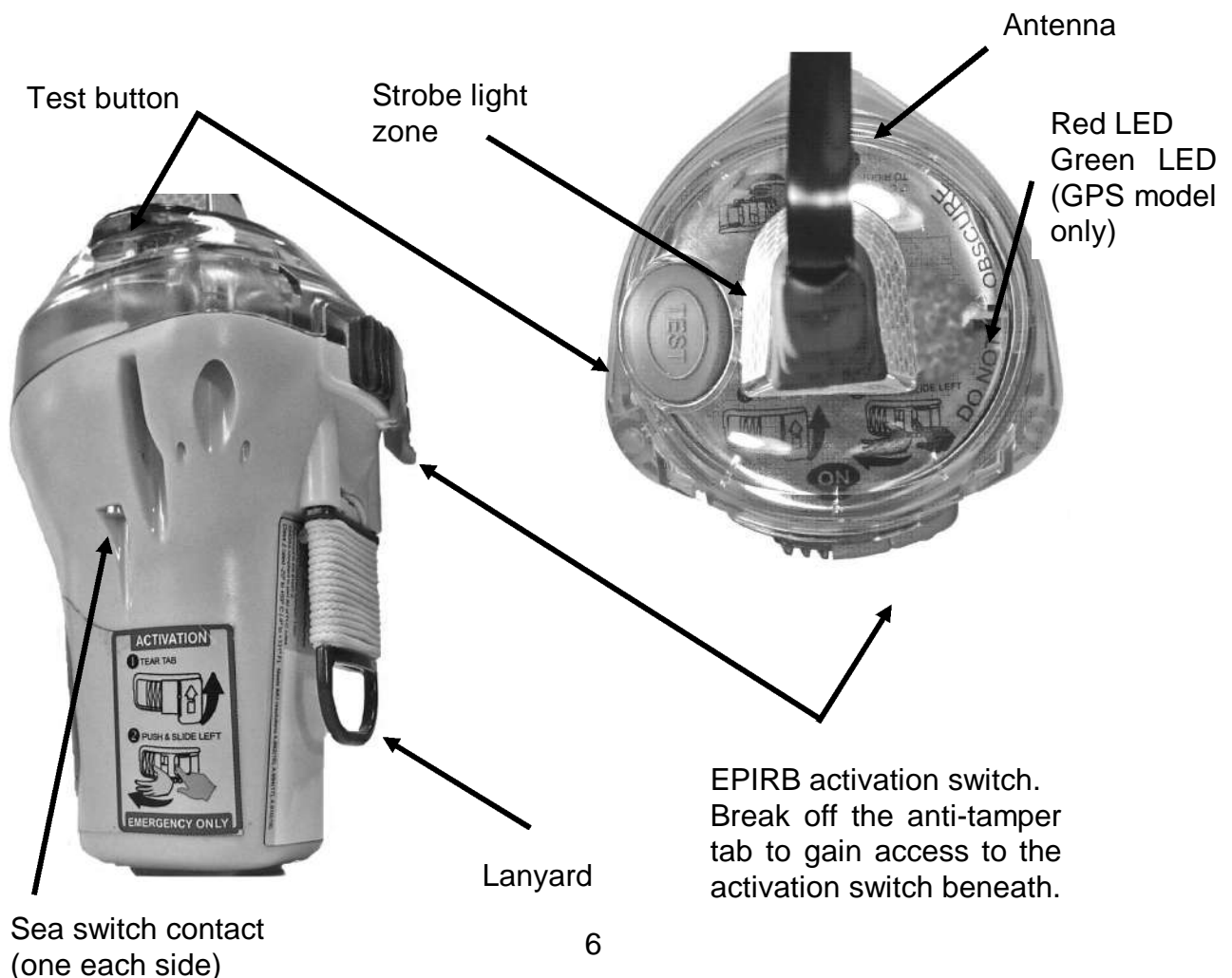

3 CONTROLS AND INDICATORS

Manual activation (switch)

The EPIRB is manually activated break off the anti-tamper tab to gain access to the manual activation switch beneath.

Automatic Sea switch (contacts)

When the EPIRB is released from its bracket a magnetic switch activates and places the EPIRB into a “ready” state. It will turn on automatically if the sea switch contacts on either side of the EPIRB body are immersed in water regardless of the status of the manual activation switch. The Automatic sea water switch has a built-in time delay to ensure that it operates correctly in rough seas. The EPIRB must be in the water for at least 2 seconds before it will automatically activate and it has to be dry for at least 8 seconds before it will stop transmitting.

TEST button

The test button is used to verify the readiness of the EPIRB.

Strobe light

Four high visibility LEDs flash simultaneously to produce the strobe light zone, this provides a visual means of locating the EPIRB.

It will start flashing immediately after the EPIRB is switched ON. Its flashing will pause for a short time when each 406 MHz alert transmission is sent, which is once every 50 seconds.

Strobe light (EPIRB ON)



1 flash every 3 seconds, pause every 50 seconds

Red LED (indicator)

The red LED illuminates when the EPIRB is first switched ON and will start to flash slowly once the first transmissions are made.

121.5 MHz transmission is taking place whenever the Red LED is flashing alternately with the strobe light.

Every 50 seconds, the red LED will flash rapidly followed by a single long flash to indicate each 406 MHz transmission.

Green LED (GPS version only)

The green LED flashes alternately with the strobe, to indicate that a valid position has been obtained by the GPS receiver. Every 50 seconds it illuminates for 2 seconds to indicate that the position is being transmitted on 406MHz. Every 20 minutes the GPS receiver updates its position information. If a fix is not obtained, the green LED stops flashing, and illuminates only every 50 seconds, when the previous position information is transmitted.

4 EPIRB STOWAGE

Bulkhead bracket (category 2)

The bulkhead bracket has two parts.

The EPIRB can be quickly unclipped from the bulkhead mount for easy stowage.

Always transport the EPIRB in the Carrysafe collar.

The Carrysafe collar keeps the EPIRB protected against accidental activation even when wet.

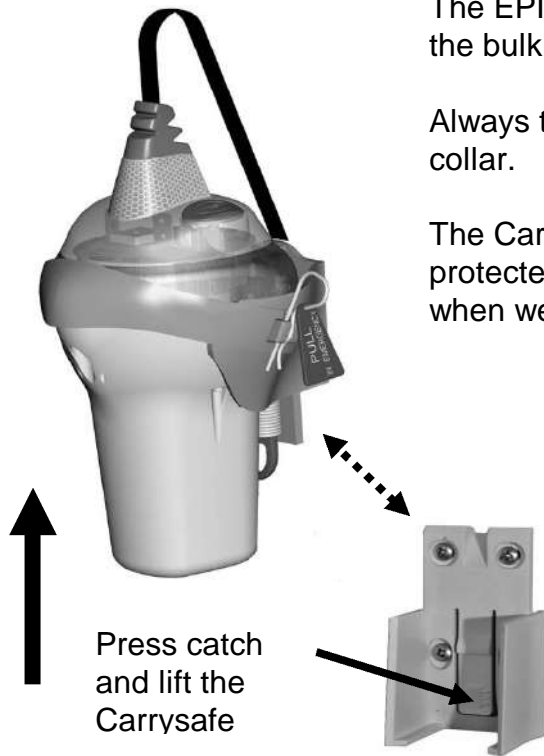

Releasing EPIRB from the bulkhead bracket

Pull the R-clip out of the bracket to release the retaining strap. Hold the antenna to prevent it springing loose and lift the EPIRB out of the mounting points.

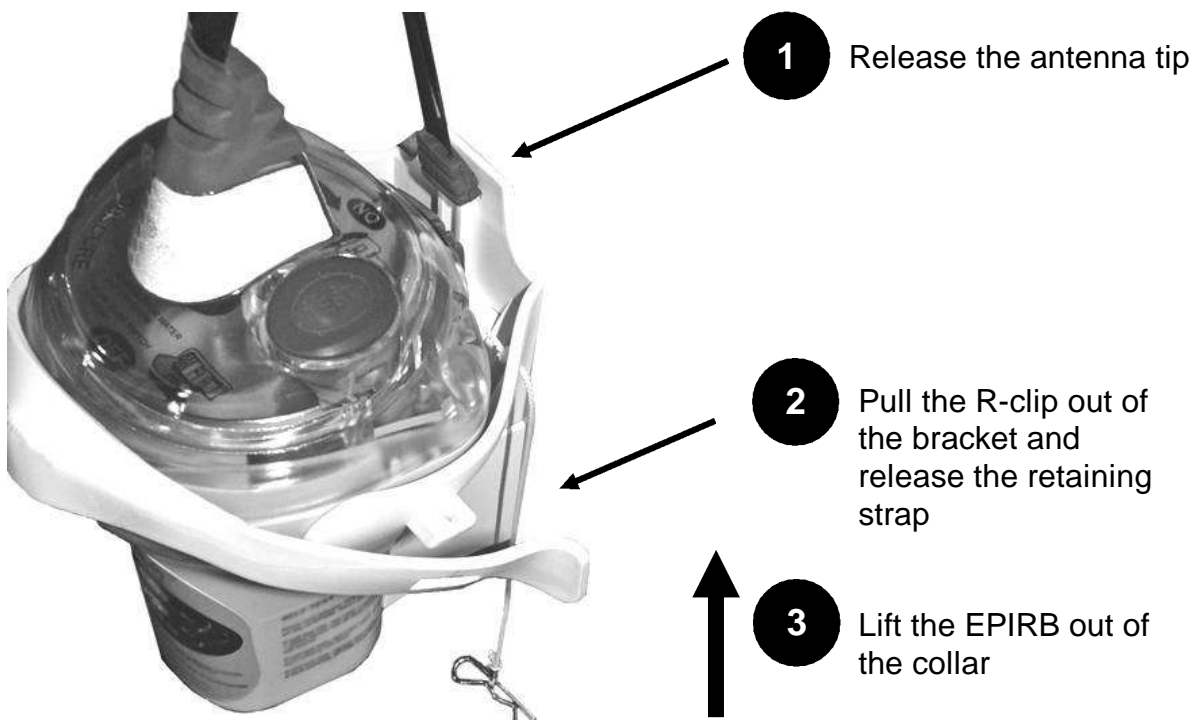

Float-free enclosure (category1)

The float-free version EPIRB has a plastic enclosure. It contains a spring-loaded lever which automatically pushes the enclosure lid off and releases the EPIRB if the vessel sinks. Automatic ejection is controlled by a Hydrostatic Release Unit (HRU) before it reaches 4 metres (13 feet) depth.

As the EPIRB floats away it automatically activates.

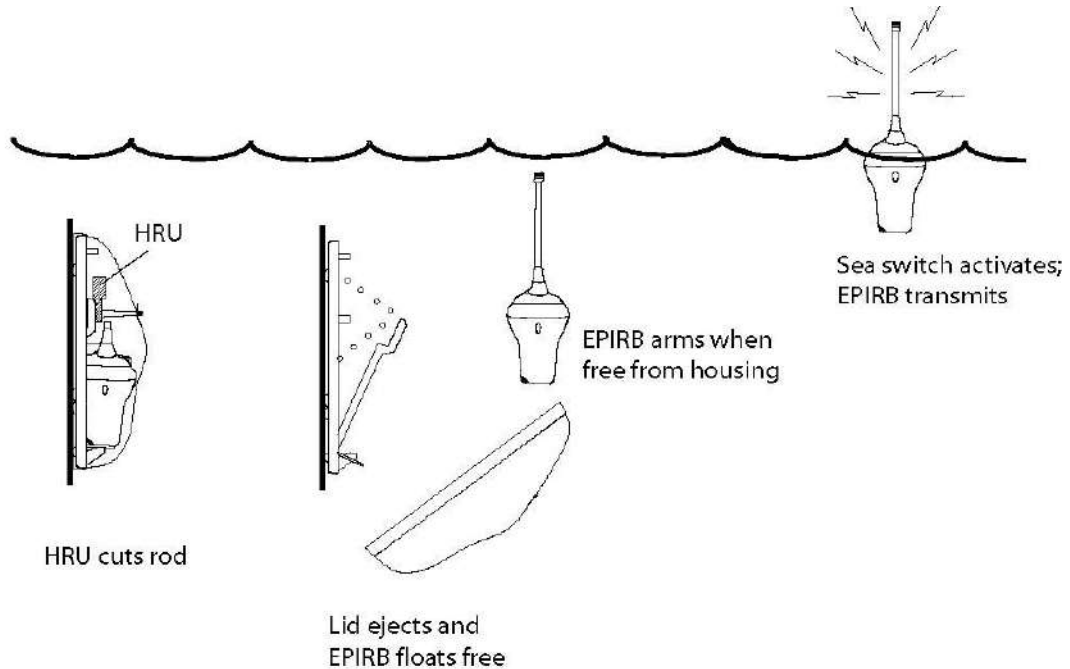

- i Never tie the EPIRB lanyard to the vessel because doing so would prevent the EPIRB from floating free.

Manually releasing EPIRB from the enclosure

Remove the R-clip from the retaining rod, then pull off the enclosure cover and remove the EPIRB.

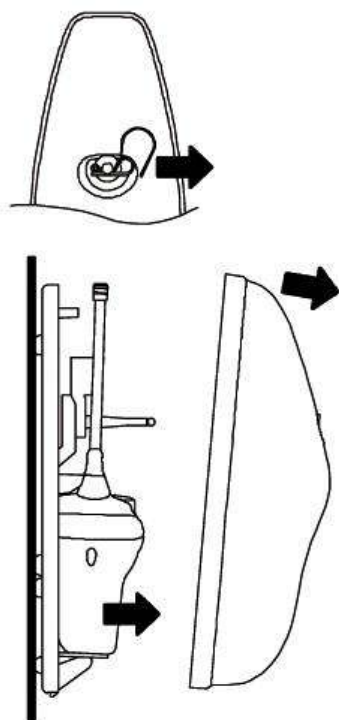

5 EPIRB OPERATING PROCEDURE

Vessel Sinking

If abandoning ship and there is time to fetch the EPIRB, release the EPIRB from its mounting bracket and carry it with you to the liferaft.

Category 1 float-free enclosure

Automatic activation

If the vessel sinks, the EPIRB will automatically release itself from its enclosure before it reaches a depth of 4 metres. The EPIRB will float to the surface and automatically start to operate.

Category 2 bulkhead bracket

Manual activation

Remove the EPIRB completely from the Carrysafe collar to gain access to the rear facing activation switch.

1. Break off the anti-tamper tab by pulling it upwards
2. Push the switch catch in and move the switch fully to the left "ON" position

When the EPIRB is first activated the strobe light will start to flash immediately and the Red LED will light. After 50 seconds has passed the Red LED will start to flash indicating that the distress transmissions have started.

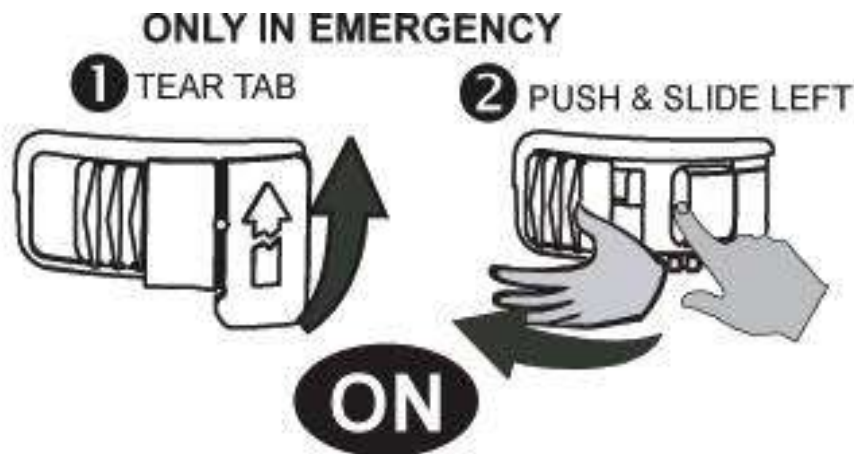

The 50 second delay before the first transmission is made allows the user to turn the EPIRB off if it was activated in error.

The antenna should be positioned as upright as possible with a clear view of the sky. Avoid handling the antenna, as this may impair performance.

Turning the EPIRB off

Should the EPIRB be activated by mistake or if the emergency ends then the EPIRB can be turned OFF by sliding the activation switch fully to the right.

REMOVE FROM WATER
AND DRY EPIRB

IF ON, SLIDE SWITCH
TO RIGHT



After water activation, dry the sea switch contacts and wait about 8 seconds for the automatic sea switch to de-activate.

The strobe light will stop flashing and the red LED will go out.

Important

After EPIRB activation and as soon as practical the EPIRB should be taken to a service agent, who will fit a new switch anti-tamper tab, and check the battery condition. If the EPIRB has been used for more than 6 hours in total, a set of fresh battery packs should be fitted to ensure the full 48 hour operational life is still available. This is necessary to ensure that in an emergency it will operate for the full 48 hours required by international regulations.

6 GETTING THE BEST FROM THE EPIRB

The EPIRB is designed and optimised to be used floating in the sea. But it can also be used in other situations.

Aboard ship:

DO:

- i Place the EPIRB in the open, clear of overhangs
- i Keep the EPIRB upright (hold it if necessary)

DO NOT:

- i Place the EPIRB close to large structures
- i Lay the EPIRB on its side
- i Place the EPIRB under cover
- i Secure the EPIRB lanyard to the vessel



In a liferaft:

- i Deploy the EPIRB so that it is visible outside of the liferaft canopy.

Uncoil the lanyard and tie it to the liferaft, then throw the EPIRB overboard so that it floats close by.

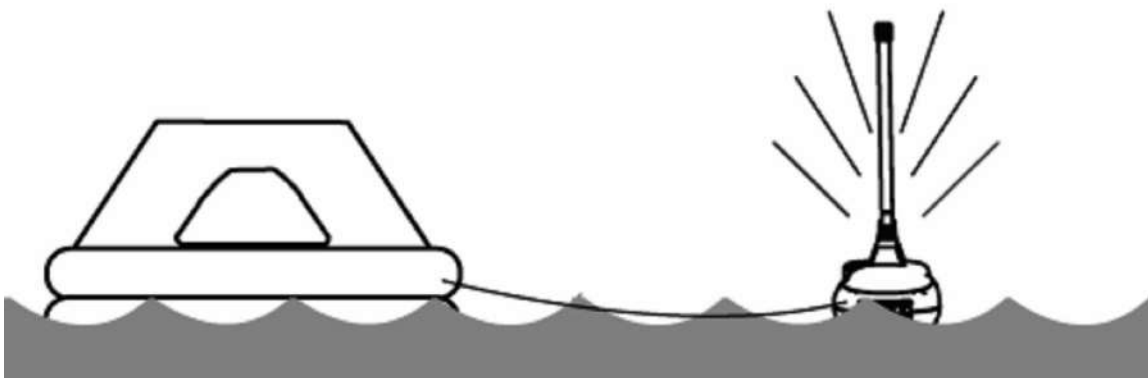

Stowing the EPIRB

Manual bracket

Hold the bracket collar open and drop the EPIRB into the bracket. The slots in the EPIRB fit over the locating lugs in the bracket.

Hold the collar shut and fit the R-clip to secure the EPIRB. Fold over the antenna and locate the end moulding in the retaining slot.



1 Align slot with lug

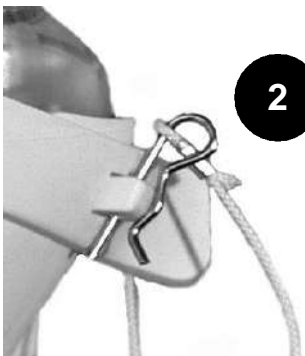

2 Fit R-clip



3 Locate end of antenna in slot

Re-fitting into enclosure

1. Place the EPIRB on its side in the enclosure with the TEST button in view.
2. Engage base of EPIRB into the recess in the lever arm.
3. Bend the antenna and retain it in the recess.
4. Refit cover squarely, engaging the guides at the top end and the rod through hole in cover.
5. Locate cover onto back plate and snap the lower end down over locating lug
6. Refit R-clip into groove at end of release rod. (Do not fit through hole)



CAUTION: Failure to fit EPIRB correctly may impair its ability to float free in an emergency.

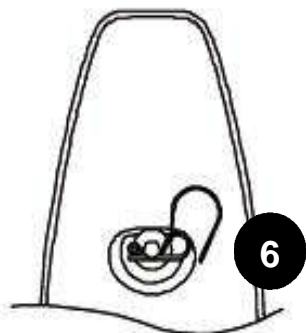
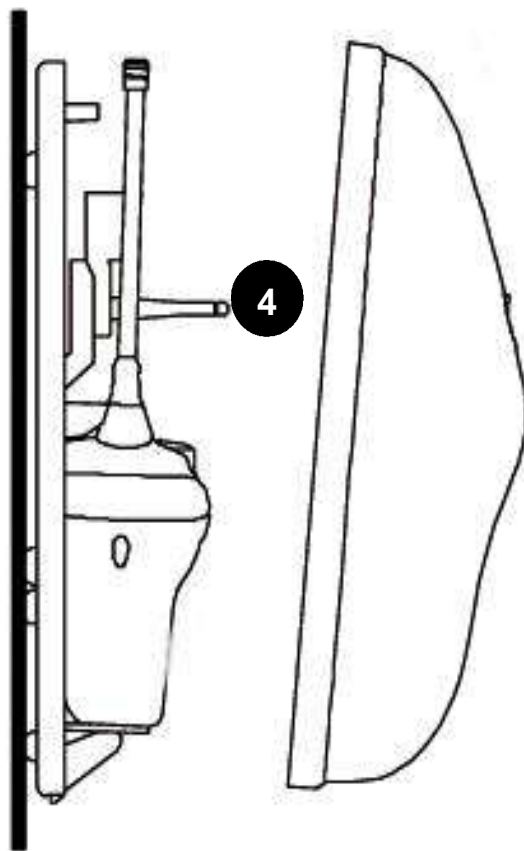
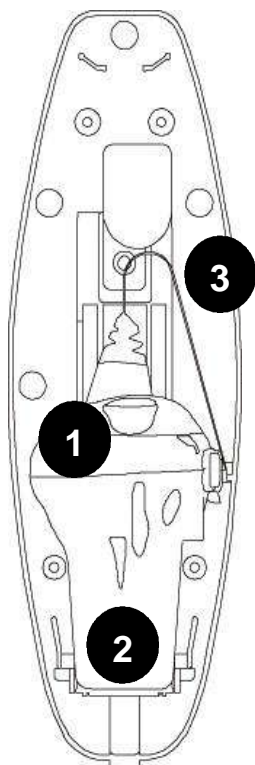

Cover correctly
snapped in place

7 FALSE ALERTS

If the EPIRB has been accidentally activated, or if rescue is affected before arrival of the rescue services:

- i Switch off the EPIRB and notify the appropriate rescue services or authorities at the earliest possible time.
- i Contact the rescue services, coastguard, or police by radio or telephone to advise them of the false alert.

You may be asked to provide the UIN (15 digit Hex ID number) of the EPIRB, date, time, duration, cause of activation and geographic location at the time you switched off the EPIRB.

Dealing with a transmitting EPIRB

In the unlikely event that the EPIRB develops a fault and will not turn off, transmissions can be prevented from reaching the satellite by cutting off the antenna close to its base. The EPIRB should then be wrapped in metal foil or placed in a sealed metal container or steel locker.

Take care when dealing with the antenna, refer to product safety warnings.

Do contact the authorities to notify them of the false alert.

Leave the EPIRB for 3 days or until the battery has fully run down before having it serviced.

Fully disabling an EPIRB

If it is necessary to fully disable an EPIRB by unplugging the battery pack, proceed as follows:

Locate a medium size cross-headed screwdriver.

Unscrew and retain the 3 sealing screws that hold the top dome onto the base section.

Lift the lens dome off and circuit board away from the base section.

Avoid touching the circuit board if possible.

Carefully unplug each of the three white battery connectors.

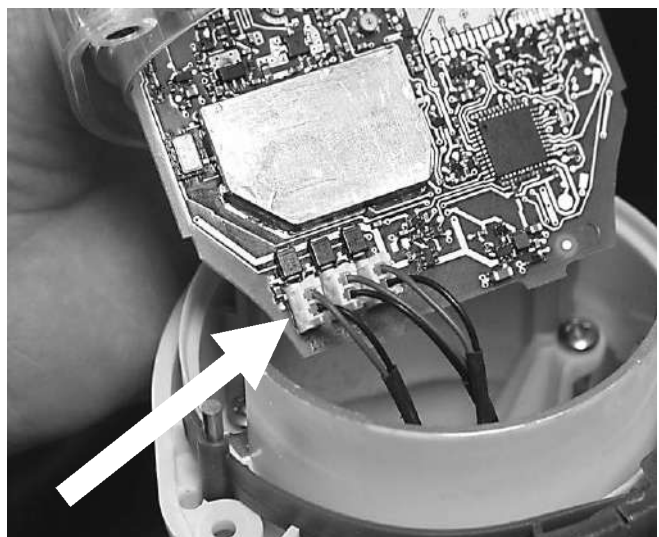

8 INSTALLATION

Bulkhead bracket

When selecting a suitable mounting position consider:

- i Ease of access in an emergency.
- i Position at least 1 metre from compass equipment and 50 cm from powerful magnets e.g. magnets found in loud speakers and radio equipment.
- i Allow sufficient clearance above the EPIRB to allow for easy removal from the bulkhead bracket.

Mounting procedure

The bulkhead bracket is designed to mount on a flat surface using four fixing points. Four stainless steel screws 25mm in length are included. Check that the rear side of the mounting surface is clear and that the fixing screws will not penetrate through into any other objects.

Offer the bracket into the chosen position and mark through the mounting slots using the bracket as a template.

Drill four 3mm (1/8") holes and securely screw the bracket in place.

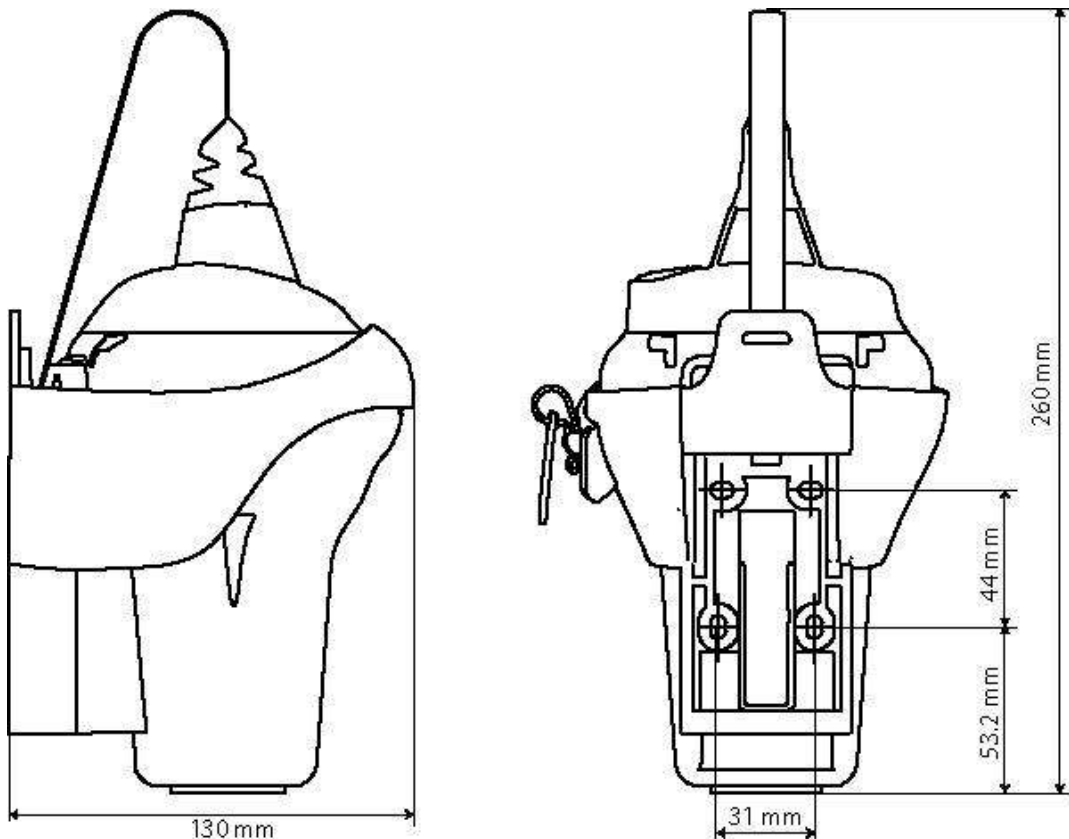

Category 1 automatic release installation

The enclosure should be mounted upright against a vertical bulkhead. Alternately, it may be mounted horizontally on a flat surface, such as a cabin roof. No other orientations are recommended.

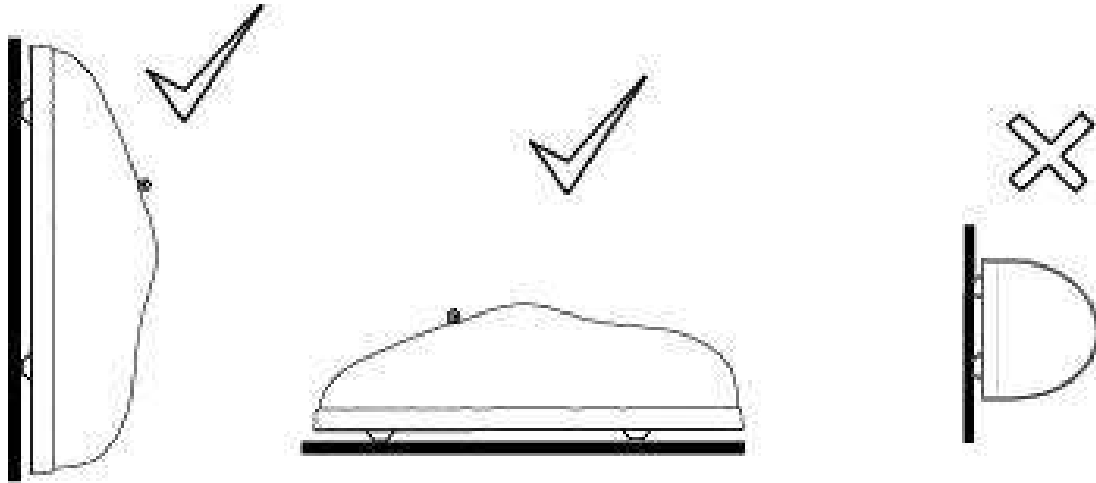

It is critical to locate the enclosure in a position where the released EPIRB will not get trapped by overhangs, rigging, antennas etc, should the vessel ever sink. An expanse of flat surface is required to allow the enclosure lid to eject.

- i Mount it where it can easily be accessed without use of a ladder
- i Mount it close to the vessel's navigation position
- i Consider ease of access in an emergency

AVOID:

- i Positions with insufficient space for lid ejection and maintenance.
- i Positions within 1m (3') of any compass equipment.
- i Mounting within 2m (6') of any Radar antenna.
- i Direct impact from waves
- i Locations where damage is possible when operating other equipment
- i Exhaust fumes, chemical and oil sources and areas of high vibration

Mounting procedure

Locate enclosure base against a flat surface using the 4 fixing points. The base plate of the enclosure can be used as a drilling guide.

1. Pull out the R-shaped clip and remove the enclosure lid. Note how the EPIRB fits then remove it to somewhere dry (its sea switch is now armed).
2. Offer the base plate into the chosen position and mark through the mounting holes.
3. The enclosure is supplied with x4 25mm (1") stainless steel wood screw fixings. 6mm (1/4") nuts and bolts can also be used (not supplied).

Category 1 enclosure installation outline

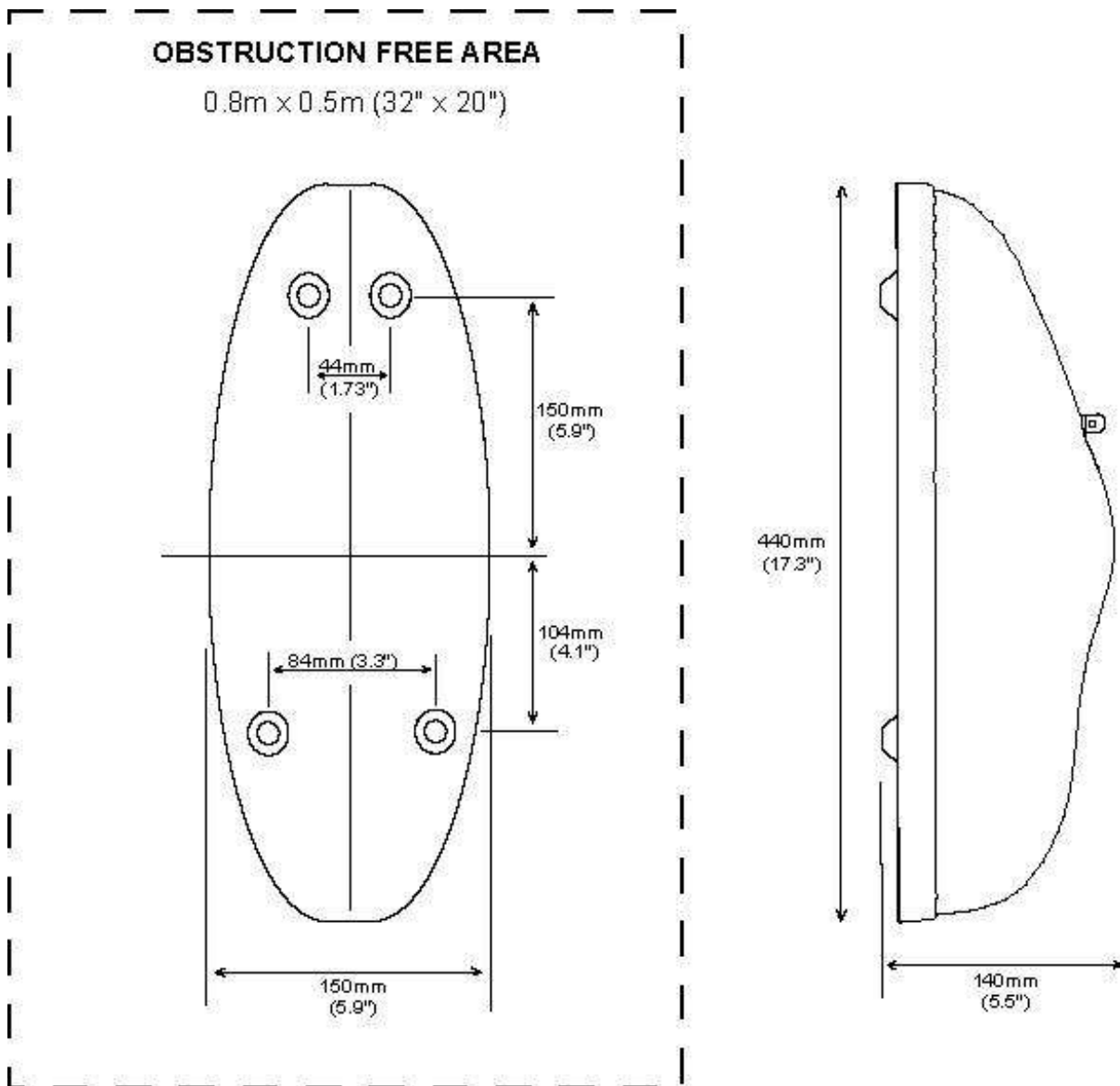

Marking Hydrostatic Release Unit (HRU) expiry (Category 1 enclosure)

The HRU has a two year in-service life starting from the date of installation of the EPIRB. The installer must mark off the month date of two years into the future on the body of the HRU and put the same month date onto the label on the outside of the enclosure.

Mark the HRU by cutting out the corresponding month and year label date.

The outside of the enclosure should be marked using the alpha-numeric stickers provided and then covered with the clear adhesive label provided. Use date format, month and year, for example: JUN 2006.

Marking vessel name

The vessel name should be marked on the EPIRB body and on the Category 1 enclosure if fitted. Alpha-numeric stickers are provided to do this, protect the markings with a section of the clear adhesive label provided.

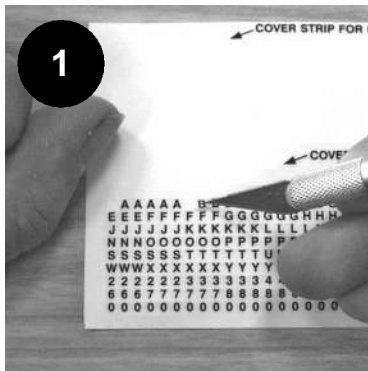

1
Lift off required letter
(a small knife blade
works well)

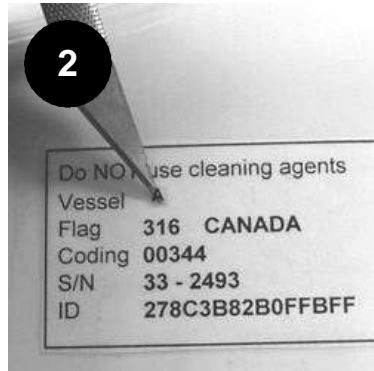

2
Apply name letters to
EPIRB rear label and
enclosure cover

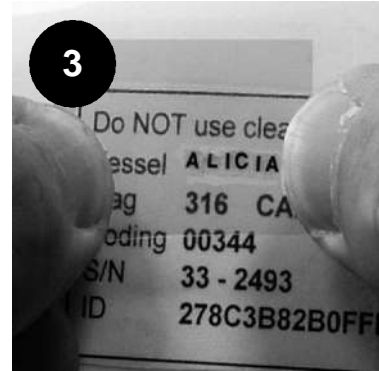

3
Cover name letters
with clear label

Instruction plate

The EPIRB is supplied with a self-adhesive instruction plate, which has basic visual instructions showing how to operate the EPIRB in an emergency.

Mount the instruction plate next to the EPIRB so that it is easily visible in an emergency.

During vessel maintenance, ensure the plate does not get painted over or cleaned down with strong degreasing solvents.

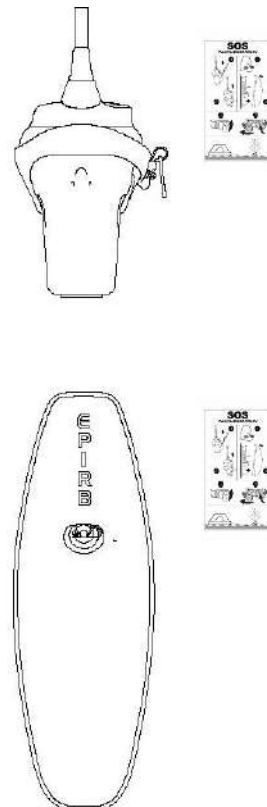
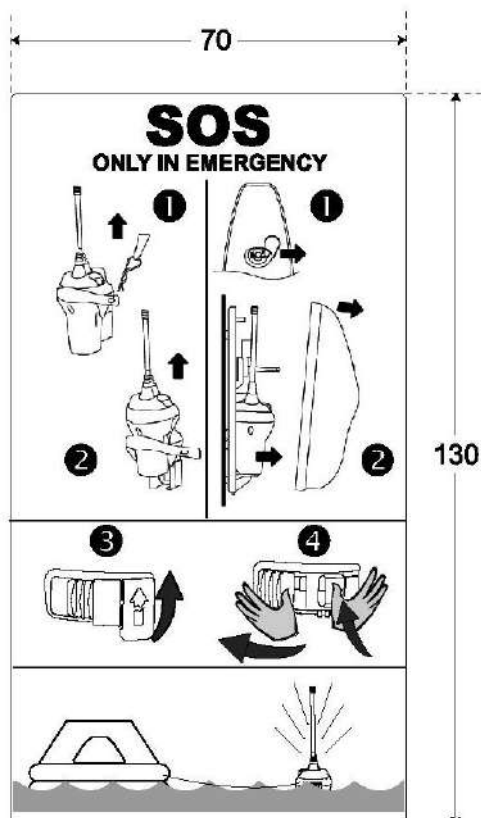

9 SELF TEST



Self test button

The EPIRB has a built-in self test capability that will confirm whether the battery is healthy, both distress transmitters are functional and that the high intensity strobe light is operational. It is recommended to self test the EPIRB **monthly**, more frequent self testing can put unnecessary drain on the battery. During the EPIRB self test, a specially coded test transmission is sent that will **not** alert the authorities. A self test can be made while the Category 2 EPIRB is held in the Carrysafe bracket, a Category1 EPIRB should be removed from the enclosure first. The self test should be carried out during the first 5 minutes of the hour so as to minimise any disturbance of the emergency channels.

1. Push and hold the TEST button down until the red LED indicator lights.
2. A successful self test will result in the red LED and strobe light flashing together a number of times.
3. The number of strobe light flashes indicates past battery usage;

Accumulated Battery Use (hours)	Number of strobe light flashes
0 to 4	3
4 to 6	2
More than 6	1

Once the self test has completed the EPIRB will switch off automatically.

A self test failure will result in **NO** strobe light flash and the red LED turning **OFF**.

Important

Each self test draws small amounts of energy from the battery pack. Unnecessary testing of the EPIRB will reduce the run time of the EPIRB in an emergency. On average, the EPIRB should only be self tested 12 times per year, or a total of 72 times during the 6 year battery lifetime.

If the EPIRB has been activated for a cumulative period in excess of 6 hours (self testing and operation), then the battery must be replaced to ensure that in an emergency it will still operate for a minimum of 48 hours at -20 pC as required by International regulations.

If the EPIRB fails self test it should be immediately removed from service.

Long self test (GPS version only)

The GPS model can also be put through a GPS long self test which includes allowing the GPS to acquire a fix. As this test consumes significant amounts of power it is restricted to a maximum of 10 tests in total.

Take the EPIRB outside under an unobstructed sky. Press and hold the TEST button until the red LED lights, then release. Wait for the standard self test to complete, then immediately the strobe light flashes, press and hold the TEST button for 15 seconds or until the red LED lights again. The red LED will stay ON and the green LED will begin to flash. The TEST button may now be released.

Typically the test will run for 15 minutes, during the test do not shield the EPIRB and do not stand over it.

A successful GPS position test will cause the green LED to light continuously for a short length of time and then go out. A fail is indicated by a continuous red LED.

10 MAINTENANCE

Routine checks

Self test the EPIRB monthly, check that the battery is in date and examine the outer case and bracket for any signs of damage. If required, clean the outer case with fresh water, wipe dry and examine the EPIRB and bracket for any damage.



CAUTION: Never use chemical solvents to clean the EPIRB or bracket.

Inspect the EPIRB and its mountings visually for deterioration or damage. The EPIRB is designed to allow water to circulate around the outer edge of the dome (inside the outer clear plastic edge but outside the waterproof seal). Consequently a volume of water in this area is of no significance.

Make the following checks;

- i lanyard is not tied to the vessel structure
- i battery is in date
- i sea switch contacts are clean
- i antenna springs to a near-vertical position when released.
- i frangible switch seal intact
- i Self test monthly

Category 2 bracket:

- i EPIRB is correctly fitted and secure in its bracket

Category 1 enclosure:

- i HRU is in date
- i EPIRB base is located into the D-shaped recess and antenna is correctly stowed
- i R clip is fitted into the groove at end of plastic rod (not through hole)

Never paint the EPIRB or its mounting bracket or enclosure, during vessel cleansing or painting always temporarily remove the EPIRB and its mounting to a safe place.

After a manual activation

The anti-tamper switch cover must be replaced by a service agent.



CAUTION: The battery may be run down and need replacement (see below).

Inadvertent operation

The anti tamper switch cover must be replaced by a service agent and the remaining battery life checked (see below).

Battery replacement

The exact battery expiry date is marked under the EPIRB lens dome and repeated on the outside of the Category 1 enclosure.

The batteries must be replaced when:

- i The expiry date has been reached **or**
- i The EPIRB has been used in an emergency situation **or**
- i A false activation exceeds 6 hours of use.
- i According to national rule or regulation

Servicing

Service of the EPIRB should only be carried out by an approved service agent. Keep the original packing material for re-use whenever the EPIRB is sent for battery replacement or service.

GMDSS inspections

Vessels that are subject to GMDSS regulations must have the EPIRB checked and tested by a ships radio surveyor enforcing national legislation. The surveyor will check the expiry dates and test activate the EPIRB to ensure that it meets the required performance criteria. They will read the identity message stored inside the EPIRB to confirm registration details. Leisure vessels are not generally subject to official EPIRB inspection, however, in some countries charter, passenger carrying and fishing vessels maybe.

Category 1 enclosure HRU replacement

The HRU has a mandatory 2 year service replacement interval.



WARNING: Failure to replace the HRU after 2 years in service has elapsed may result in the EPIRB not automatically deploying in an emergency.



CAUTION: It is most important that all of the supplied replacement parts are fitted, never reuse an old plastic rod or fixing E-clip.

Only ever fit an original McMurdo replacement HRU Kit:

Part No.82-962-001A. McMurdo Breakthru HRU,

The kit includes HRU, a replacement breakable plastic rod, e-clip, washer, date labels and instruction sheet.

HRU replacement procedure:

1. Remove enclosure R-clip and cover
2. Remove the EPIRB, stow it in a dry place **It may activate if allowed to get wet**
3. Hold down the lever arm to take up the force of the spring
4. Push the HRU back then upwards out of the slot in the lever arm
5. When the rear clip disengages slowly release the lever arm
6. The HRU with its breakable rod can now be lifted free and replaced
7. Fit the new HRU over the new rod, with its label facing outward
8. Fit the replacement washer and new E-clip, ensure rod moves freely
9. Mark the HRU with an expiry date 2 years into the future
10. Slide the HRU into the slot in the lever arm and push lever arm down
11. Engage rear washer into back-plate by pushing back and sliding down
12. Look under the spring and check that the washer is fully engaged
13. Re-Fit the EPIRB, cover and R-clip
14. On side of cover, remove old HRU expiry date and mark new date.

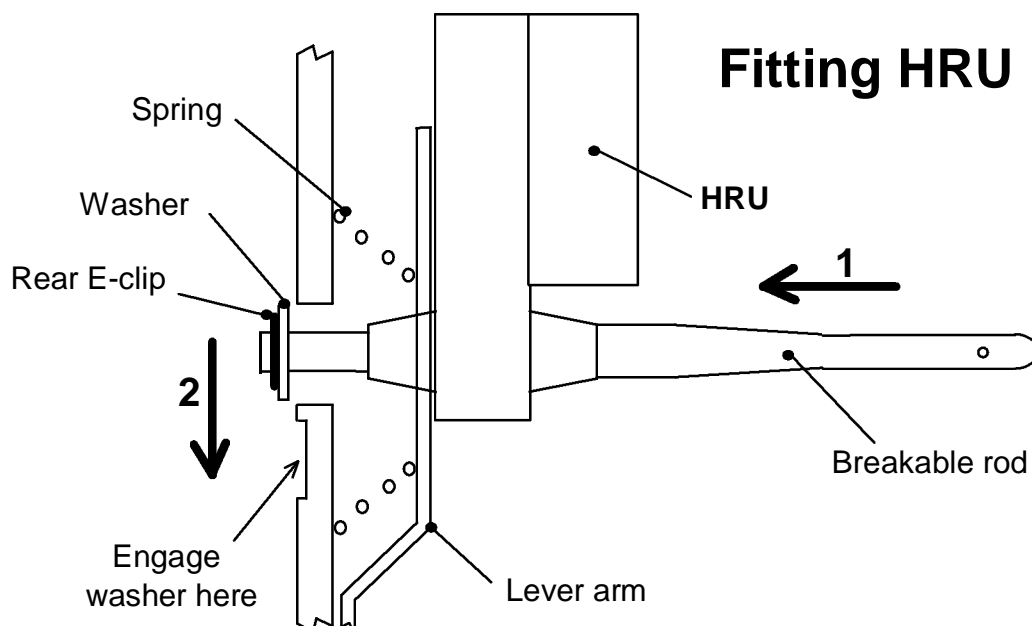

Transportation

Passenger Aircraft

This product contains small lithium metal batteries. The EPIRB can normally be taken on board a passenger aircraft as a personal item in carry-on hand baggage. We recommend declaring the EPIRB to airline staff at check in, in the same way you would for a laptop PC or video camera.

As air cargo

This product contains small lithium metal batteries and may be classed as 'not restricted' for air cargo when handled according to requirement PI 970 of the IATA Dangerous Goods Regulations (52nd Edition). Always check with the carrier concerned for any additional shipment restrictions that may apply.

11 SPECIFICATION

406 MHz Transmitter	Operating frequency	406.040 MHz \pm 1 kHz
	Power output	5 W typical
	Modulation	Phase (16K0GID)
121.5 MHz Homer	Operating frequency	121.5 MHz \pm 3.5 kHz
	Power output	50 mW radiated typical
	Modulation	Swept tone AM (3K20A3X)
Strobe light	Type	Four high intensity LEDs
	Light output	0.75 cd minimum
	Flash rate	23 flashes per minute
GPS Receiver (Smartfind G5 Plus only)	Centre frequency	1.57542 GHz
	Sensitivity	-175 dBW minimum
	Operating life	48 hours minimum
	Shelf life	6 years typical in service
Environment	Operating temperature	-20 $^{\circ}$ C to +55 $^{\circ}$ C (-4 $^{\circ}$ F to +131 $^{\circ}$ F)
	Storage temperature	-30 $^{\circ}$ C to +70 $^{\circ}$ C (-22 $^{\circ}$ F to +158 $^{\circ}$ F)
	Automatic release depth	4 metres max. (13 feet)
Physical	Weight	770 grams (1.7 lb)
	Height of body	21 cm (8.2 inches)
	Length of antenna	18 cm (7 inches)
Approvals	Satellite system	Cospas-Sarsat T.001/T.007
	Europe	IEC 61097-2 Marine Equipment Directive
	USA	USCG/FCC approved FCC ID : KLS-E5-1
	Worldwide	IEC 61097-2
	Meets IMO regulations	A.662(16); A.694(17); A.810(19); A.814(19)

This device complies with the GMDSS provisions of part 80 of the FCC rules.

EC Declaration of Conformity

Hereby Orolia Ltd declares that this EPIRB is in compliance with the essential requirements and other relevant provisions of the Marine Equipment Directive (MED) – 96/98/EC. A copy of the Declaration Of Conformity can be obtained on line from;

www.mcmurdomarine.com/documents

12 WARRANTY STATEMENT

IMPORTANT

Orolia Ltd warranty registration

Congratulations on purchasing your beacon. As standard your unit has a one year (12 months) warranty from the date of purchase shown on your invoice, however, this can be extended by a further four years by simply registering your unit on-line at:

www.mcmurdomarine.com

Then follow the REGISTER WARRANTY link at the top of the page.

Warranty Statement

Subject to the provisions set out below Orolia Ltd warrants that this product will be free of defects in materials and workmanship for a period of up to five years (see above) from the date of purchase. Orolia Ltd will not be liable to the buyer under the above warranty:-

for any defect arising from fair wear and tear, wilful damage, negligence, abnormal working conditions, failure to follow Orolia Ltd's instructions (whether oral or in writing) including a failure to install properly and/or to use batteries recommended and/or supplied by Orolia Ltd, misuse or alterations or repair of the product by persons other than Orolia Ltd or an Approved Service Agent;

for parts, materials or equipment not manufactured by Orolia Ltd in respect of which the buyer shall only be entitled to the benefit of any warranty or guarantee given by the manufacturer to Orolia Ltd;

for the battery storage life which is specifically excluded from this warranty;

if the total price for the product has not been paid.

THE LIMITED WARRANTY STATED ABOVE IS EXCLUSIVE AND IN LIEU OF ANY OTHER WARRANTY, EXPRESS OR IMPLIED, INCLUDING BUT NOT LIMITED TO ANY IMPLIED WARRANTY OF MERCHANTABILITY OR FITNESS FOR A PARTICULAR PURPOSE. Orolia Ltd will not be liable for indirect, special, incidental or consequential damages of any kind sustained from any cause. In no event shall Orolia Ltd be liable for any breach of warranty or other claim in an amount exceeding the purchase price of the product. This warranty does not affect any statutory rights of the consumer. In order to be valid, claims must be made under the above warranty in writing as soon as practicable after discovery of the defect or failure and within the warranty period referred to above. Proof of purchase will be required. The claim should be sent together with the product in question to the address set out below or to an Approved Service Agent. Following a valid warranty claim Orolia Ltd shall be entitled to repair or replace the product (or part) in question free of charge, or at Orolia Ltd's sole discretion to refund to the buyer the price of the product (or a proportional part of the price). Orolia Ltd shall not be liable to a buyer who is not a consumer for any other loss or damage (whether indirect, special or consequential loss of profit or otherwise) costs, expenses or other claims for compensation which arise out of or in connection with this product. In the case of a consumer Orolia Ltd shall only be liable where other loss or damage is foreseeable.

Nothing shall limit Orolia Ltd's liability for death or personal injury caused by its negligence. This warranty is to be interpreted under English law.

All enquiries relating to this warranty or Approved Service Agents should be sent to:

Orolia Ltd, Silver Point, Airport Service Road, Portsmouth, Hampshire, PO3 5PB, UK

Telephone: Int + 44 (0) 23 9262 3900 Fax: Int + 44 (0) 23 9262 3998

Web: www.mcmurdomarine.com Email: service.mcmurdo@orolia.com

An Orolia Group Business

13 END OF LIFE STATEMENT

At the end of the EPIRB's useful life, it is vital that the battery be disconnected from the main unit to prevent false alarms. False alarms cause expensive disruption to Search and Rescue services and may endanger lives as a consequence. It is also necessary that the EPIRB and its battery pack be disposed of in a manner that does not present a threat of environmental damage.

Battery Removal instruction

Refer to section 7.

Disposal



Contains traces of lithium, may contain traces of lead and brominated flame retardants (BFRs), both in the housing material and circuit boards.



DO NOT INCINERATE

Orolia Ltd strongly recommends that this EPIRB product and its battery pack be disposed of in a sensible and considerate manner. For example, do not simply discard the product in the domestic waste. Instead take it to a civil recycling facility, or contact Orolia Ltd for advice.

Green Passport: Ship Recycling Information

Orolia Ltd hereby declares potentially hazardous content in some of its electronic products. Small amounts of the following substances may be present: beryllium oxide, lithium, lead, brominated flame retardants, glass.

In keeping with European directive 2002/96/EC (Waste Electronic and Electrical Equipment) and the provisions of IMO Resolution A.962(23) (Guidelines On Ship Recycling), Orolia Ltd strongly recommends that its products, including any battery packs, be disposed of in a considerate and legal manner.

14 ANNEX 1. REGISTRATION INFORMATION

Registration of 406MHz satellite EPIRBs with the EPIRB Registration Section of the national authority is mandatory, due to the global alerting nature of the Cospas-Sarsat system. The information provided in the registration is used only for search and rescue purposes.

If the EPIRB is to enter service immediately, complete the registration card and fax or email the information to the relevant national authority. Some administrations allow for on line registration. The authorities will normally provide the registered user with a DECAL label which you are obliged to fit to the EPIRB body as 'proof of registration'.

General information related to EPIRB registration requirements around the World is published by the Cospas-Sarsat organisation. Some administrations now allow direct registration using the Cospas-Sarsat website online IBRD registration database.

Further information can be found on line here: www.cospas-sarsat.org

Additional registration information by country

<p>Austria Point of contact: Frequency Office Federal Ministry for Transport Tel: +43 1 33181621 Fax: +43 1 33181649 Email: ernst.cerny@bmvit.gv.at Online registration: n/a</p>	<p>Australia Point of contact: Beacon Registration Section, AusSAR Tel: +61 2 6279 5766 or 1800 406 406 Fax: +61 2 9332 6323 or 1800 406 329 Email: ausbeacon@amsa.gov.au Online registration: www.beacons.amsa.gov.au</p>
<p>Owners in Australia please note the following requirement from the Australian Standards Authority. "Advice to owners of EPIRBs". Registration of 406MHz satellite EPIRBs with the EPIRB Registration Section of the National Authority is mandatory because of the global alerting nature of the system. The information provided in the registration card is used only for rescue purposes. Fill in the owner registration card immediately upon completion of the sales transaction. Mail the registration card immediately. If the beacon is to enter service immediately, complete the registration card and fax the information to the national authority. The original card must still be mailed to the relevant national authority for hard-copy reference and filing. If the current owner is transferring the beacon to a new owner, the current owner is required to inform the national authority by letter, fax or telephone the name and address of the new owner. The subsequent owner of the beacon is required to provide the national authority with the information as shown in the owner registration card. This obligation transfers to all subsequent owners"</p>	
<p>Belgium Point of contact: IBPT Tel: +32 2 2268856 Fax: +32 2 2268802 Email: bmr@bipt.be Online registration: n/a</p>	<p>Canada Canadian Beacon Registry Phone: 1-877-406-SOS1 (7671) Fax: 1-877-406-FAX8 (3298) or email: CBR@sarnet.dnd.ca Address: CFB Trenton PO Box 1000 Stn Forces Astra, ON K0K 3W0</p>

<p>Finland Point of contact: The Finnish Communications Regulatory Authority Tel: +358 9 69661 Fax: +358 9 6966410 Web: www.ficora.fi</p>	<p>France Point of contact: FMCC Tel: +33 5 61274636 Fax: +33 5 61274878 Email: fmcc@cnes.fr Online registration: https://registre406.cnes.fr</p>
<p>Greenland (Denmark) Point of contact: Greenland Telecom Administration Tel: +45 35430333 Fax: +45 35431434 Email: n/a</p>	<p>India Point of contact: INMCC/ISTRAC/ISRO Tel: +91 80 28371857 Fax: +91 80 28371857 Email: inmcc@istrac.org Online registration: n/a</p>
<p>Ireland Point of contact: Maritime Radio Affairs Unit Tel: +353 1 6782367 Fax: +353 1 6783109 Email: radiosurveyors@transport.ie Online registration: n/a</p>	<p>Italy Point of contact: ITMCC Tel: +39 080 5341571 Fax: +39 080 5342145 Email: itmcc247@cospas-sarsat-italy.it Online registration: www.cospas-sarsat-italy.it</p>
<p>Netherlands Point of contact: Radio Communications Agency Tel: +31 50 5877555 Fax: +31 50 5877400 Email: agentschaptelecom@at-ez.nl www: www.agentschap-telecom.nl Online: n/a</p>	<p>New Zealand Point of contact: Rescue Co-ordination Centre New Zealand Tel: +64 4 577 8033 Fax: +64 4 577 8041 Email: 406registry@maritimenz.govt.nz Online registration: n/a</p>
<p>Norway Point of contact: Post and Telecommunications Authority Tel: +47 2 2824600 Fax: +47 2 2824890 Email: inger-lise.walter@npt.no Online registration: n/a</p>	<p>Portugal Point of contact: Navigation, Transport, Marine inspector Tel: +351 21 3913529 Fax: +351 21 3979794 Email: n/a Online registration: n/a</p>
<p>South Africa Point of contact: SASAR, MRCC Cape Town Tel: +27 21 9383310 Fax: +27 21 9383319 Email: mrcc.ct@samsa.org.za Online registration: n/a</p>	<p>Sweden Point of contact: MRCC Goteborg Tel: +46 31 699080 Fax: +46 31 648010 Email: n/a Online registration: http://www.pts.se/sv/radioutrustning/nodsandare</p>

<p>Switzerland Point of contact: Federal Office of Communications Tel: +41 32 3275511 Fax: +41 32 3275555 Email: n/a Online registration: n/a</p>	<p>UK Point of contact: The EPIRB Registry, The Maritime and Coastguard Agency Tel: 01326 211569 Fax: 01326 319264 Email: epirb@mcga.gov.uk Online registration: www.mcga.gov.uk/c4mca/epirb</p>
<p>USA Important information Beacon registration is now available on-line. This is the preferred method of registration; point your browser to http://www.beaconregistration.noaa.gov and follow the instructions on-screen. Use the EPIRB form.</p> <p>Other Information At present, NOAA still accepts registration by mail or fax. The registration forms are pre-printed with the correct mailing address and fax number. A registration form may be downloaded from the website given above. However you register the beacon, you will be sent a decal which must be attached to the beacon.</p> <p>Emergency Contact It is VITAL that the Emergency Contact information is accurate, particularly regarding the telephone number, as this will be used to validate an alert. Only if the beacon registration and approximate location details can be confirmed will USCG (United States Coast Guard) launch an immediate rescue, otherwise there will be a delay whilst further alerts from the same source are received and verified.</p> <p>Registration address: NOAA SRSAT Beacon Registration NSOF, E/SP3, 4231 Suitland Road Suitland MD 20746 FAX: 301-817-4565 Helpline: 301-817-4515 or toll-free: 1-888-212-SAVE (7283).</p>	

If the registration details for your country are not shown here, please check for latest information at www.mcmurdomarine.com/documents

Sale or transfer

If the EPIRB or vessel is being transferred to a new owner, the current owner should inform the national authority by email, facsimile, letter or telephone of the name and address of the new owner. The new owner of the beacon is required to provide the national authority with the information as shown on the registration card. This obligation transfers to all subsequent owners.'

National serialised EPIRBs such as are sold in USA, Canada, UK, Australia and New Zealand do not normally need to be re-programmed when transferred to a different vessel provided the vessel is under the same flag state. The new owner should (detail above) complete a new registration. In most other countries, the EPIRB must be re-programmed with either the new vessel's Maritime Mobile Station Identity (MMSI) or its radio callsign, whichever is required by the country controlling the new vessel. Since the EPIRB identity contains a country code, it follows that changing the flag state of the vessel also means the EPIRB must be re-programmed. For details of your nearest agent, either contact Orolia Ltd using the details in the warranty section, or visit the service section of the web site:-www.mcmurdomarine.com

Orolia Ltd

Silver Point

Airport Service Road

Portsmouth PO3 5PB

United Kingdom

Phone: +44 (0)23 9262 3900

Fax: +44 (0)23 9262 3998

Email: service.mcmurdo@orolia.com

Website: www.mcmurdomarine.com

An Orolia Group Business

